



HUSKYTM

User manual PRO range display chillers and display freezers



To ensure safe operation, please read this user manual thoroughly before use.

© 2017 Husky. Husky reserve the right to change specifications at any time without notice.
Images used are for illustration only. Stock not included.





Welcome to your new Husky

Thank you for buying this Husky commercial chiller/freezer. It has been designed and manufactured for many years of trouble-free service.

Operation is very simple, but please take a few minutes to read this user manual. It contains important safety information, and tips to ensure you receive the best possible service from your Husky unit.

CONTENTS

Important Notes.....	3
Warning! Risk of electrical shock hazard.....	3
Disposal of old refrigerators.....	3
Safety instructions and warnings.....	3
Before using for the first time.....	4
Troubleshooting.....	5
Standard Range C4PRO, C5PRO, C8PRO, & C10PRO.....	6
Operating Instructions.....	6
Exploded diagram.....	7
Circuit diagrams.....	9
Wiring diagram.....	11
Intelligenza Range C4PRO-IT, C5PRO-IT, C8PRO-IT, & C10PRO-IT.....	12
Operating Instructions.....	12
Exploded diagram.....	13
Circuit diagrams.....	15
Wiring diagram.....	17
Below Zero Range C4PRO-ZZ, C5PRO-ZZ, C8PRO-ZZ & C10PRO-ZZ.....	18
Operating Instructions.....	18
Exploded diagram.....	19
Circuit diagrams and wiring diagram.....	21
Cassette Range C4PRO-CA, C5PRO-CA & C10PRO-CA.....	22
Operating Instructions.....	22
Exploded diagram.....	23
Circuit diagrams.....	25
Wiring diagram.....	27
Freezer Range F5PRO & F10PRO.....	28
Operating Instructions.....	28
Exploded diagram.....	29
Circuit diagrams.....	31
Wiring diagram.....	31





All models

Important Notes

WARNING: RISK OF ELECTRICAL SHOCK HAZARD

This refrigeration unit must be earthed.

If the power cable is damaged, it must be replaced by a qualified engineer to avoid shock hazard. **DO NOT ATTEMPT TO SERVICE THE ITEM YOURSELF.** Ensure that the unit is properly earthed. Stop using the unit immediately if electric shock is felt when touching the cabinet.



DISPOSAL OF OLD REFRIGERATORS & FREEZERS

BE SURE TO MAKE ANY LOCKS UNUSABLE. IF POSSIBLE, REMOVE THE DOOR(S) AND DISCARD SEPARATELY.

WARNING – CHEMICAL HAZARD: DO NOT ALLOW CHILDREN TO PLAY WITH OLD REFRIGERATORS OR FREEZERS. CONTACT YOUR LOCAL AUTHORITY FOR PROPER DISPOSAL PROCEDURES.

Before disposing of an old refrigerator or freezer, please make sure it is switched off and safe. Unplug the unit and break any locks in order to avoid children becoming trapped.

Please note: the refrigeration system contains gases and refrigerants which require specialist waste disposal. The valuable materials contained in a refrigerator or freezer can be recycled.

Contact your local waste disposal depot for proper disposal of an old unit and contact your local authority or dealer if you have any questions.

Ensure the pipework of the old unit is not damaged prior to disposal. You can contribute to the environmental awareness by insisting on an appropriate non-polluting method of disposal.

USERS IN EUROPE – WEEE COMPLIANCE

Husky chillers and freezers are authorised to carry the CE (Conformité Européene) and WEEE (Waste Electrical and Electronic Equipment Directive) symbols.

The WEEE symbol on this chiller/freezer indicates that the product must not be disposed of with household waste. To help prevent possible harm to health and the environment, the product must be disposed of by recycling methods authorised as environmentally safe. For more information on how to dispose of this product appropriately, contact your dealer or the recycling department at your local authority.

Husky chillers/freezers and their components undergo strict product testing by independent companies to comply or exceed all applicable local and international regulatory standards.



SAFETY INSTRUCTIONS & WARNINGS

Before switching on your Husky commercial chiller or freezer, read the information in this user manual carefully. The user manual contains important observations relating to the assembly, operation and maintenance of the unit.

Please keep this user manual in a safe place for future reference. If you ever sell this unit, hand this user manual to the new owner.





The manufacturer does not accept responsibility for any damages that may arise due to non-observation of these instructions.

- Do not use the unit if it is damaged. If you are in any doubt, consult an engineer.
- Connection and installation of your Husky unit are to be carried out in strict compliance with the relevant instructions in this user manual.
- Make sure there is a suitable power outlet with proper grounding to power the unit.
- For safety, the unit must be properly earthed in accordance with specifications.
- Always remember to unplug the unit before cleaning. Never unplug this unit by pulling on the power cable. Always grip plug firmly and pull straight out from the socket.
- All electrical repairs must be carried out by a qualified engineer. Inadequate repairs may be dangerous.
- Do not damage any parts of the chiller/freezer which carry refrigerant by piercing, perforating, crushing, twisting or scraping. If refrigerant comes into contact with the eyes it may cause serious eye injury.
- Do not obstruct or cover the ventilation grille.
- Do not allow children to play with the unit, or to sit on it or hang onto the door.
- This unit is not intended for use by persons (including children) with reduced physical, sensory or mental capabilities, or lack of experience and knowledge, unless they have been given supervision or instruction concerning use of the unit by a person responsible for their safety.

BEFORE USING FOR THE FIRST TIME



IMPORTANT: Before switching the unit on, we recommend you allow it to stand upright for 8 hours. Failure to do this may result in damage to the unit.

- Remove the wooden pallet and the packing.
- To ensure correct operation, it is important that the unit is level. The cabinet may be levelled by turning either or both of the adjustable feet in the front corners. Use a spirit level to check.
- Before operation, we recommend that the cabinet is cleaned for reasons of hygiene and to remove any residue left from manufacture.
- For good circulation, vents must not be blocked. Keep a minimum of 100mm of clear space around the chiller/freezer. Your Husky unit should be placed on flat and firm surface for quieter operation.
- Do not expose the unit to direct sunlight or a heat source such as ovens, radiators, heaters, etc.
- Do not under any circumstances place heated food or beverages in your Husky commercial chiller/freezer.
- Do not open the door more often than necessary to lessen the escape of cold air.
- For better air circulation, do not overfill the unit.
- Adjust the thermostat according to the amount of product and the ambient temperature.





Troubleshooting

Before calling Technical Support, please check the following points; you may be able to solve any problem yourself.

Problem	Possible Cause	Action
The chiller/freezer does not work properly.	The unit is not plugged in.	Connect the plug to the power supply
	The plug and/or the power cable are faulty.	Call your supplier or a qualified engineer.
	The fuse has blown.	Replace the fuse with one of the same rating.
	The unit is faulty.	Call your supplier or a qualified engineer.
The chiller or freezer's internal temperature is too high or too low.	The wrong temperature is selected.	Check the controller and adjust the set temperature.
	The factory default settings for the controller are incorrect.	Call your supplier or a qualified engineer.
	The condenser is blocked by an accumulation of dust.	Clean using a vacuum cleaner and soft brush attachment (see pages 8, 14, 20, or 24)
	The doors are not fully closed.	Check the unit is level and the seals are not damaged.
	The chiller/freezer is close to a heat source or the ambient temperature is too high.	Move the unit to a better location and check it is out of direct sunlight.
	The ventilation grille is blocked.	Move the chiller to improve free movement of air.
The chiller/freezer is noisy in operation or makes unusual noises. • <i>Note: It is normal to hear some noises as refrigerant flows through the compressor.</i>	The unit is not on a level, firm surface, or the unit may be touching other items.	Check location and position using a spirit level.
	The chiller/freezer is vibrating against a neighbouring object.	Relocate the chiller or the object.
Outer surfaces are wet	The unit may be close to a water source or leak.	Dry surfaces thoroughly and move the unit.
Inner surfaces are wet	The door may be opened too often or kept open too long.	Try to minimise opening of the doors for better cooling performance.





Standard Range C4PRO, C5PRO, C8PRO, & C10PRO

Operating Instructions

TO OPERATE THE ELECTRONIC THERMOSTAT

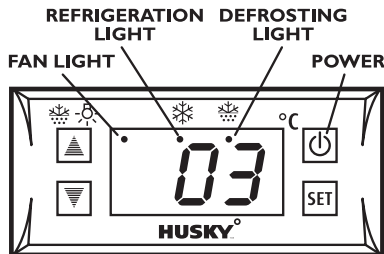

The thermostat has been pre-set, and in most cases it is not necessary to adjust the settings. When the unit is operating normally, the display will show the current temperature.

To display the set temperature press the **SET** button. Press the button again to return to normal operation.

To set a new temperature, press **SET**. The display will flash and the current set temperature will be displayed. Press the **▲** button to increase the set temperature, or press the **▼** button to decrease the set temperature. Press the **SET** button to save the new setting. The display will flash with the new value and then revert to display the cabinet temperature.

Please note:

1. When the chiller is connected to the mains for the first time there will be a short delay before cooling starts. During this time the Refrigeration Light will flash. After the short delay, cooling will begin and the Refrigeration Light will be illuminated. When the chiller reaches the set temperature, the Refrigeration Light will be off.
2. If you do not press any button, after six seconds the controller will return to its normal display.

To switch the chiller off, press **⏻** for six seconds. The display will show "- -". To switch the chiller back on, press **⏻** for one second. The display will show the cabinet temperature and the unit will enter normal working mode.

DEFROSTING

The unit defrosts automatically at preset intervals. If however the door is opened too often, or if the unit is in a location with high humidity, or if the contents are changed more frequently, it may be necessary to defrost the unit manually. To start or stop manual defrosting, press the **▲** button for six seconds. The Defrosting Light will be illuminated. Melt water runs to a container placed in the compressor compartment and evaporates. After defrosting is complete, the unit will return to normal operation.

INTERIOR LIGHT

Press the **▲** button to switch the light on or off.

EVAPORATOR FAN

As part of the chiller's normal operation the evaporator fan will switch off automatically when





Exploded Diagram

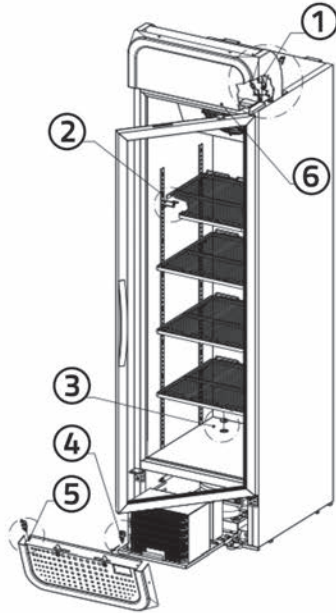

Standard Range C4PRO & C5PRO

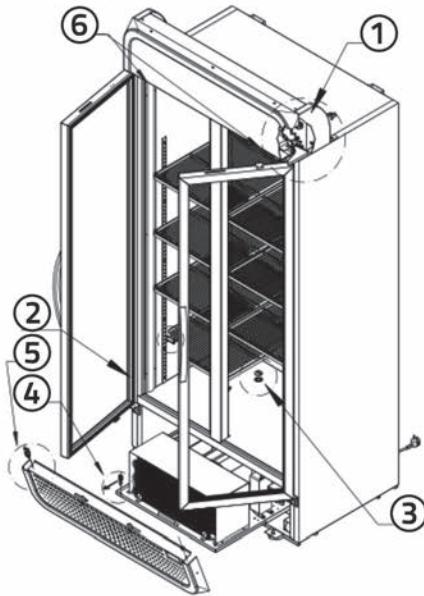

Standard Range C8PRO & C10PRO

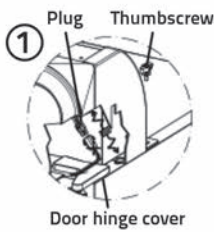

Door hinge cover



Shelf clip

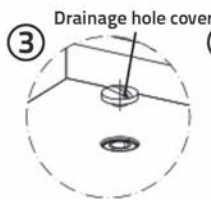

Drainage hole cover

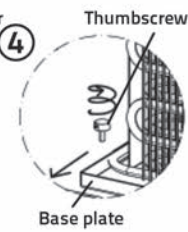

Base plate

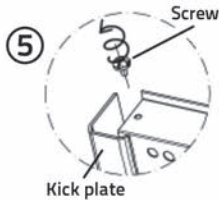

Kick plate

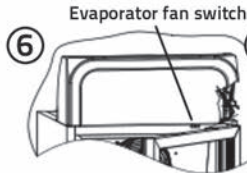

Evaporator fan switch

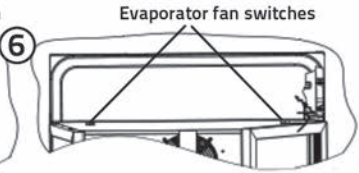

Evaporator fan switches





Standard Range C4PRO, C5PRO, C8PRO, & C10PRO

the door is opened. The switch is located in the top of the door rebate (see Fig. 6 on page 7).

INSTALLING SHELVES

Fit the shelf clips to the ladder racks (see Fig. 2 on page 7) and install the shelves horizontally. Ensure the clips are located firmly and the shelves are secure before loading the chiller.

FITTING/REMOVING THE ILLUMINATED CANOPY

QUALIFIED ENGINEERS ONLY. To fit the canopy, first disconnect the chiller from the power supply. Remove the right hand door hinge cover. Plug the canopy into the socket that may now be seen. See Fig. 1 on page 7. Tighten the thumb screws on both sides of the canopy to secure the canopy to the chiller. Re-connect the chiller to the power supply.

To remove the canopy, first disconnect the chiller from the power supply. Loosen the thumb screws on both sides of canopy, then pull out the plug for the canopy light – see Fig. 1 on page 7. The canopy may now be removed. Re-fit the right hand door hinge cover. Finally re-connect the chiller to the power supply.

EASY MAINTENANCE ACCESS

QUALIFIED ENGINEERS ONLY. Husky chillers are designed for easy maintenance. One feature is that the compressor, condenser and condenser fan are mounted on an easily-accessible sliding tray. To access this sliding tray, open the door(s) fully and loosen the two screws (which have now become accessible) on the top on either side of the kick plate – see Fig 5 on page 7. Remove the kick plate by lifting it up and pulling it forward. Loosen the thumb screws on either side of the sliding tray – see Fig. 4 on page 7. With caution slide out the sliding tray no more than 300mm.

COMPRESSOR

QUALIFIED ENGINEERS ONLY. To access the compressor, slide out the sliding tray – see 'Easy Maintenance Access'.

CLEANING

The condenser and the compressor compartment **MUST** be cleaned quarterly – see 'Easy Maintenance Access' how to access the compressor compartment.

The external and internal surfaces of the unit should be cleaned regularly. Switch the unit off and disconnect the plug from the mains socket. Remove the drainage hole cover (see Fig. 3 on page 7). Clean the external and internal surfaces of the unit with a mild soap solution, then wipe dry. Replace the drainage hole cover. Do NOT use cleansers containing chlorine or other harsh cleansing agents, as these can damage the stainless steel surfaces and components. Use mild soapy water to clean the gasket and seals.

GETTING SERVICE ASSISTANCE

The cooling system is a hermetically sealed circuit and does not require any maintenance other than regular cleaning (see 'Cleaning').

If the unit fails to work, first check the power supply. If you cannot locate the reason for the failure, please contact your supplier, stating the model and serial number of the cabinet. You may find this information on the rating plate, which is affixed inside the unit on the top right-hand interior wall.





Circuit Diagrams

C4PRO & C5PRO Standard models, no canopy

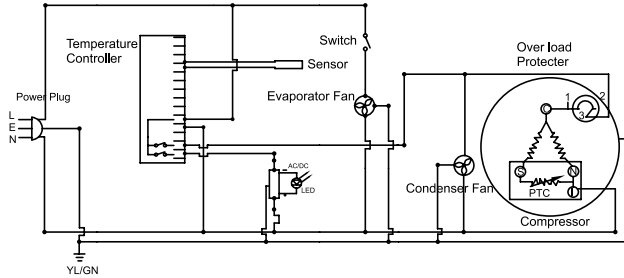

C4PRO & C5PRO Standard models with canopy

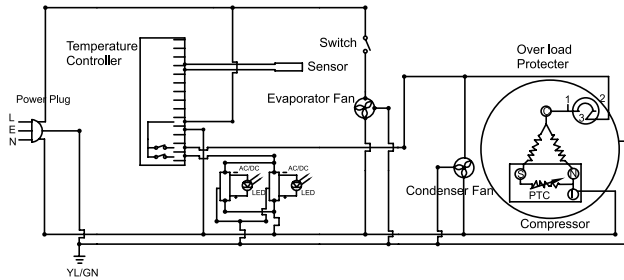

C8PRO & C10PRO Standard models, no canopy

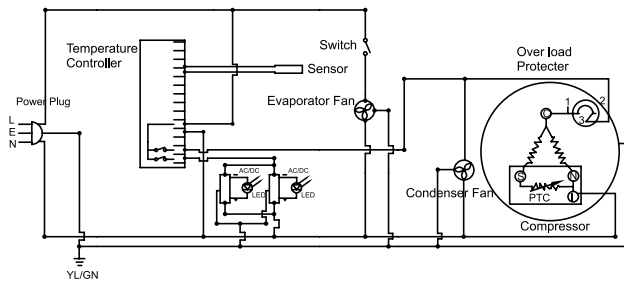



Standard Range C4PRO, C5PRO, C8PRO, & C10PRO

Circuit Diagrams

C8PRO & C10PRO Standard models with canopy

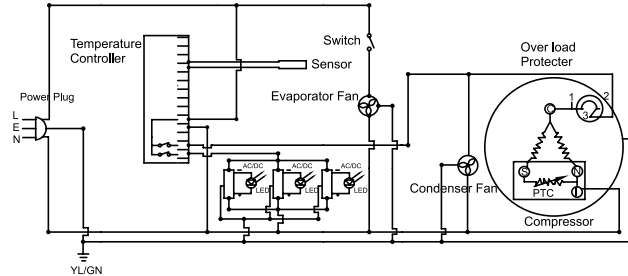

C8PRO & C10PRO Standard models with door heater, no canopy

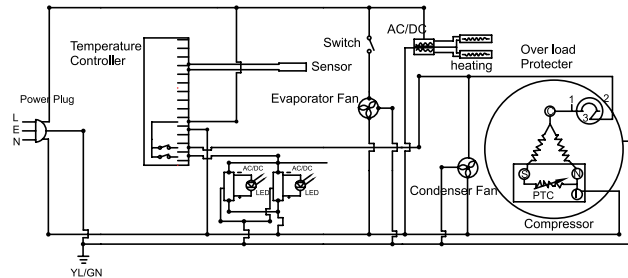

C8PRO & C10PRO Standard models with door heater and canopy

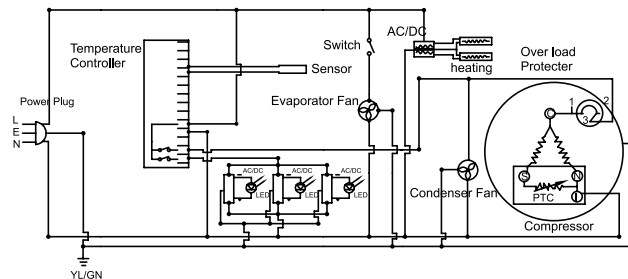



Wiring Diagram

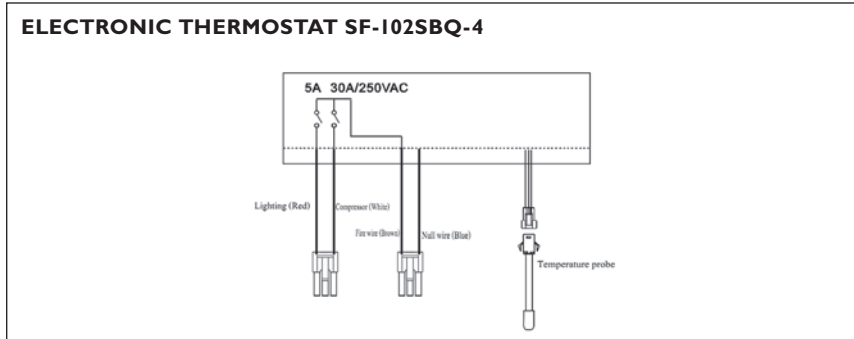



Intelligenza Range C4PRO-IT, C5PRO-IT, C8PRO-IT, & C10PRO-IT

Operating Instructions

TO OPERATE THE ELECTRONIC THERMOSTAT

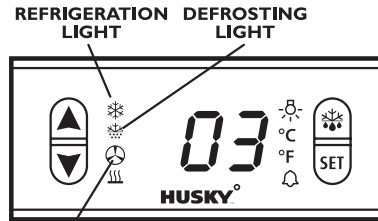

FAN LIGHT

The thermostat has been pre-set, and in most cases it is not necessary to adjust the settings. When the unit is operating normally, the display will show the current temperature.

To display the set temperature press the **SET** button. Press the button again to return to normal operation.

To set a new temperature, press **SET**. The display will flash and the current set temperature will be displayed. Press the **▲** button to increase the set temperature, or press the **▼** button to decrease the set temperature. Press the **SET** button to save the new setting. The display will flash with the new value and then revert to display the cabinet temperature.

Please note:

1. When the chiller is connected to the mains for the first time there will be a short delay before cooling starts. During this time the Refrigeration Light will flash. After the short delay, cooling will begin and the Refrigeration Light will be illuminated. When the chiller reaches the set temperature, the Refrigeration Light will be off.
2. If you do not press any button, after six seconds the controller will return to its normal display.

DEFROSTING

The unit defrosts automatically at preset intervals. If however the door is opened too often, or if the unit is in a location with high humidity, or if the contents are changed more frequently, it may be necessary to defrost the unit manually. To start or stop manual defrosting, press the **☸** button for six seconds. The Defrosting Light will be illuminated. Melt water runs to a container placed in the compressor compartment and evaporates. After defrosting is complete, the unit will return to normal operation.

INTELLIGENZIA MODE

The Husky Intelligenza range is designed for superior energy efficiency. If the chiller is not opened for two hours, the unit enters its energy-saving Intelligenza mode. The evaporator fan and compressor will stop, and the internal temperature will increase from 4°C to 9°C. All these features are part of the Intelligenza range's normal operation.

INTERIOR LIGHT

Press the **▲** button to switch the light on or off.





Exploded Diagram

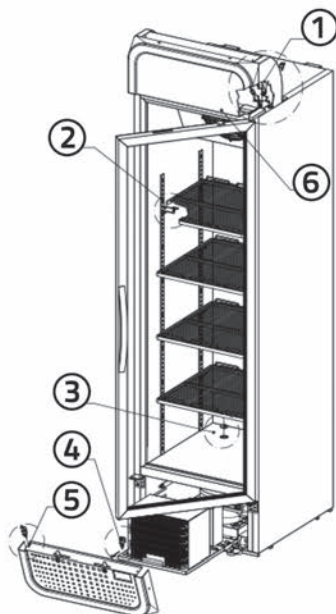

Intelligenza Range C5PRO-IT

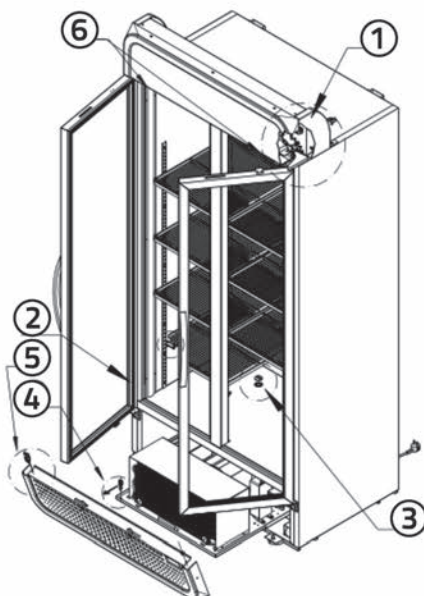

Intelligenza Range C8PRO-IT & C10PRO-IT

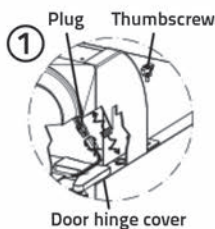

Door hinge cover



Shelf clip

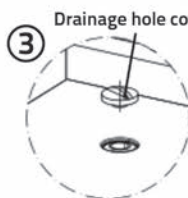

Drainage hole cover

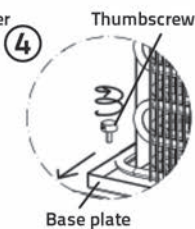

Base plate

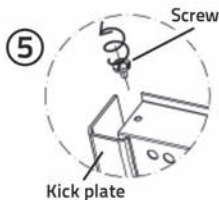

Kick plate

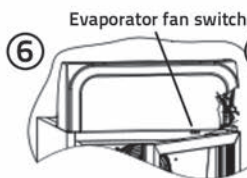

Evaporator fan switch

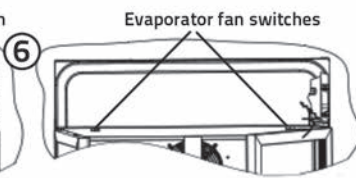

Evaporator fan switches





Intelligenza Range C4PRO-IT, C5PRO-IT, C8PRO-IT, & C10PRO-IT

EVAPORATOR FAN

As part of the chiller's normal operation the evaporator fan will switch off automatically when the door is opened. The switch is located in the top of the door rebate (see Fig. 6 on page 13).

INSTALLING SHELVES

Fit the shelf clips to the ladder racks (see Fig. 2 on page 13) and install the shelves horizontally. Ensure the clips are located firmly and the shelves are secure before loading the chiller.

FITTING/REMOVING THE ILLUMINATED CANOPY

QUALIFIED ENGINEERS ONLY. To fit the canopy, first disconnect the chiller from the power supply. Remove the right hand door hinge cover. Plug the canopy into the socket that may now be seen. See Fig. 1 on page 13. Tighten the thumb screws on both sides of the canopy to secure the canopy to the chiller. Re-connect the chiller to the power supply.

To remove the canopy, first disconnect the chiller from the power supply. Loosen the thumb screws on both sides of canopy, then pull out the plug for the canopy light – see Fig. 1 on page 13. The canopy may now be removed. Re-fit the right hand door hinge cover. Finally re-connect the chiller to the power supply.

EASY MAINTENANCE ACCESS

QUALIFIED ENGINEERS ONLY. Husky chillers are designed for easy maintenance. One feature is that the compressor, condenser and condenser fan are mounted on an easily-accessible sliding tray. To access this sliding tray, open the door(s) fully and loosen the two screws (which have now become accessible) on the top on either side of the kick plate – see Fig 5 on page 13. Remove the kick plate by lifting it up and pulling it forward. Loosen the thumb screws on either side of the sliding tray – see Fig. 4 on page 13. With caution slide out the sliding tray no more than 300mm.

COMPRESSOR

QUALIFIED ENGINEERS ONLY. To access the compressor, slide out the sliding tray – see 'Easy Maintenance Access'.

CLEANING

The condenser and the compressor compartment MUST be cleaned quarterly – see 'Easy Maintenance Access' how to access the compressor compartment.

The external and internal surfaces of the unit should be cleaned regularly. Switch the unit off and disconnect the plug from the mains socket. Remove the drainage hole cover (see Fig. 3 on page 13). Clean the external and internal surfaces of the unit with a mild soap solution, then wipe dry. Replace the drainage hole cover. Do NOT use cleansers containing chlorine or other harsh cleansing agents, as these can damage the stainless steel surfaces and components. Use mild soapy water to clean the gasket and seals.

GETTING SERVICE ASSISTANCE

The cooling system is a hermetically sealed circuit and does not require any maintenance other than regular cleaning (see 'Cleaning').

If the unit fails to work, first check the power supply. If you cannot locate the reason for the failure, please contact your supplier, stating the model and serial number of the cabinet. You may find this information on the rating plate, which is affixed inside the unit on the top right-hand interior wall.





Circuit Diagrams

C4PRO & C5PRO Intelligenza/Intelligenza Cassette models, no canopy

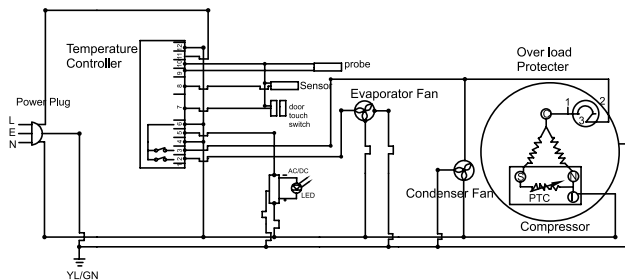

C4PRO & C5PRO Intelligenza/Intelligenza Cassette models with canopy

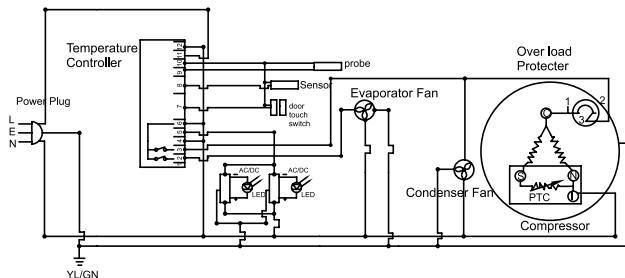

C8PRO & C10PRO Intelligenza/Intelligenza Cassette models, no canopy

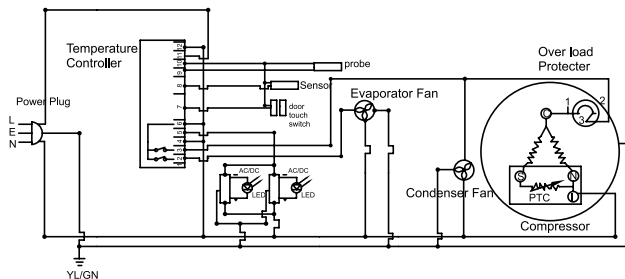



Intelligenza Range C4PRO-IT, C5PRO-IT, C8PRO-IT, & C10PRO-IT

Circuit Diagrams

C8PRO & C10PRO Intelligenza/Intelligenza Cassette models with canopy

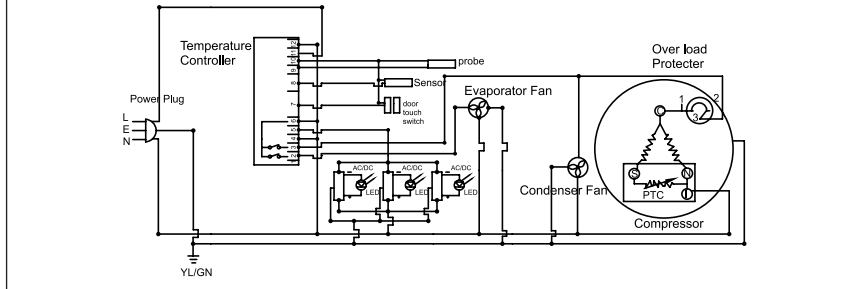

C8PRO & C10PRO Intelligenza/Intelligenza Cassette models with door heater, no canopy

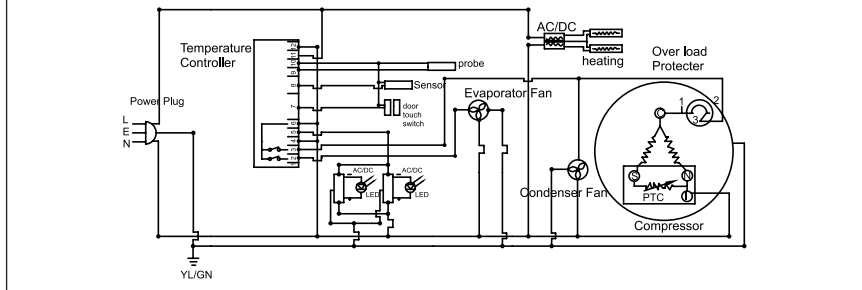

C8PRO & C10PRO Intelligenza/Intelligenza Cassette models with door heater and canopy

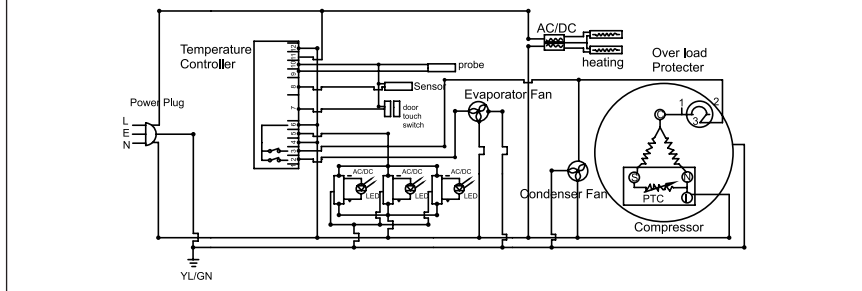



Wiring Diagram

ELECTRONIC THERMOSTAT SF-402

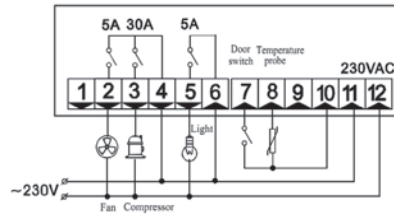



Below Zero Range C4PRO-ZZ, C5PRO-ZZ, C8PRO-ZZ & C10PRO-ZZ

Operating Instructions



IMPORTANT: The Husky Below Zero range is designed to blast chill beverages only down to -3°C . Do not store food or medicines in a Below Zero cabinet under any circumstances.

TO OPERATE THE ELECTRONIC THERMOSTAT

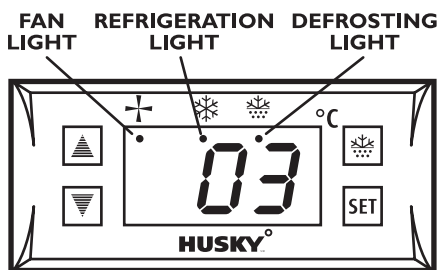

The thermostat has been pre-set, and in most cases it is not necessary to adjust the settings. When the unit is operating normally, the display will show the current temperature.

To display the set temperature press the **SET** button. Press the button again to return to normal operation.

To set a new temperature, press **SET**. The display will flash and the current set temperature will be displayed. Press the **▲** button to increase the set temperature, or press the **▼** button to decrease the set temperature. Press the **SET** button to save the new setting. The display will flash with the new value and then revert to display the cabinet temperature.

Please note:

1. When the chiller is connected to the mains for the first time there will be a short delay before cooling starts. During this time the Refrigeration Light will flash. After the short delay, cooling will begin and the Refrigeration Light will be illuminated. When the chiller reaches the set temperature, the Refrigeration Light will be off.
2. If you do not press any button, after six seconds the controller returns to normal display.

DEFROSTING

The unit defrosts automatically at preset intervals. If however the door is opened too often, or if the unit is in a location with high humidity, or if the contents are changed more frequently, it may be necessary to defrost the unit manually. To start or stop manual defrosting, press the **DEF** button for six seconds. The Defrosting Light will be illuminated. Melt water runs to a container placed in the compressor compartment and evaporates. After defrosting is complete, the unit will return to normal operation.

INTERIOR LIGHT

Press the **▲** button to switch the light on or off.





Exploded Diagram

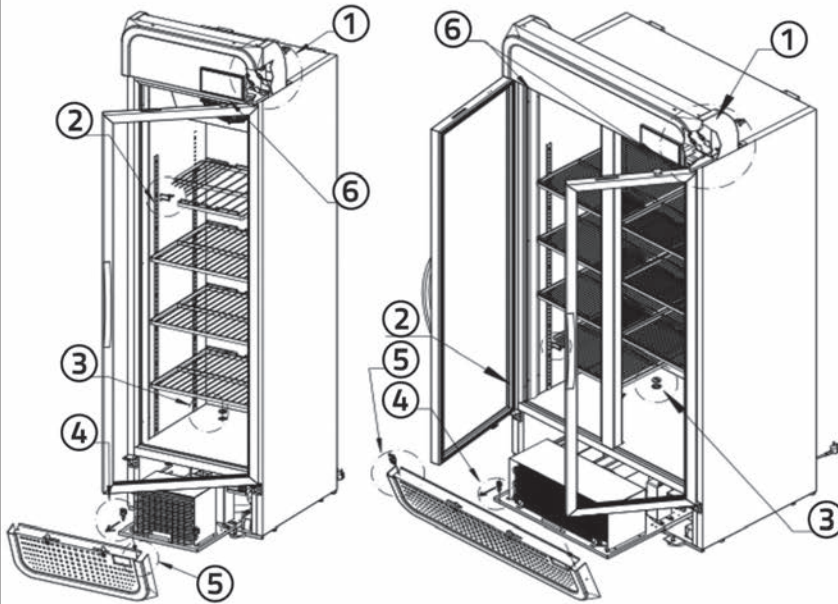

Below Zero Range C5PRO-ZZ

Below Zero Range C8PRO-ZZ & C10PRO-ZZ

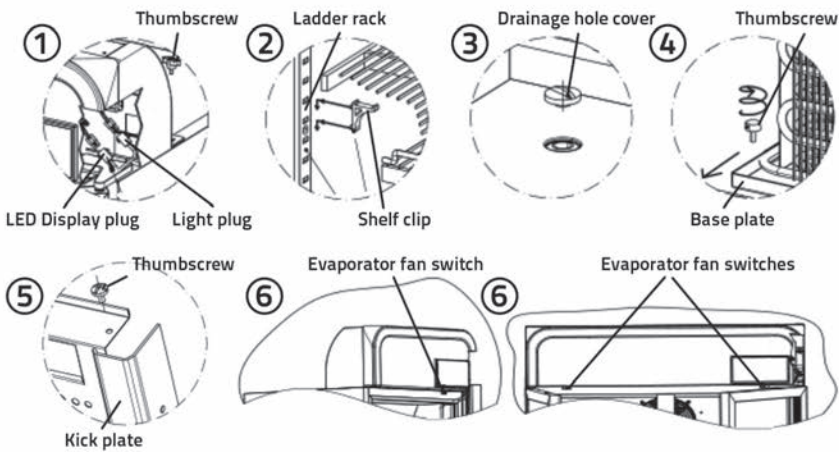



Below Zero Range C4PRO-ZZ, C5PRO-ZZ, C8PRO-ZZ & C10PRO-ZZ

EVAPORATOR FAN

As part of the chiller's normal operation the evaporator fan will switch off automatically when the door is opened. The switch is located in the top of the door rebate (see Fig. 6 on page 19).

INSTALLING SHELVES

Fit the shelf clips to the ladder racks (see Fig. 2 on page 19) and install the shelves horizontally. Ensure the clips are located firmly and the shelves are secure before loading the chiller.

FITTING/REMOVING THE ILLUMINATED CANOPY

QUALIFIED ENGINEERS ONLY. To fit the canopy, first disconnect the chiller from the power supply. Remove the right hand door hinge cover. Plug the canopy light and the LED display into the sockets that may now be seen. See Fig. 1 on page 19. Tighten the thumb screws on both sides of the canopy to secure the canopy to the chiller. Re-connect the chiller to the power supply. To remove the canopy, first disconnect the chiller from the power supply. Loosen the thumb screws on both sides of canopy, then pull out the two plugs for the canopy light and LED display – see Fig. 1 on page 19. The canopy may now be removed. Re-fit the right hand door hinge cover. Finally re-connect the chiller to the power supply.

EASY MAINTENANCE ACCESS

QUALIFIED ENGINEERS ONLY. Husky chillers are designed for easy maintenance. One feature is that the compressor, condenser and condenser fan are mounted on an easily-accessible sliding tray. To access this sliding tray, open the door(s) fully and loosen the two screws (which have now become accessible) on the top on either side of the kick plate – see Fig 5 on page 19. Remove the kick plate by lifting it up and pulling it forward. Loosen the thumb screws on either side of the sliding tray – see Fig. 4 on page 19. With caution slide out the sliding tray no more than 300mm.

COMPRESSOR

QUALIFIED ENGINEERS ONLY. To access the compressor, slide out the sliding tray – see 'Easy Maintenance Access'.

CLEANING

The condenser and the compressor compartment MUST be cleaned quarterly – see 'Easy Maintenance Access' how to access the compressor compartment.

The external and internal surfaces of the unit should be cleaned regularly. Switch the unit off and disconnect the plug from the mains socket. Remove the drainage hole cover (see Fig. 3 on page 19). Clean the external and internal surfaces of the unit with a mild soap solution, then wipe dry. Replace the drainage hole cover. Do NOT use cleansers containing chlorine or other harsh cleansing agents, as these can damage the stainless steel surfaces and components. Use mild soapy water to clean the gasket and seals.

GETTING SERVICE ASSISTANCE

The cooling system is a hermetically sealed circuit and does not require any maintenance other than regular cleaning (see 'Cleaning').

If the unit fails to work, first check the power supply. If you cannot locate the reason for the failure, please contact your supplier, stating the model and serial number of the cabinet. You may find this information on the rating plate, which is affixed inside the unit on the top right-hand interior wall.





Circuit Diagrams

C4PRO-ZZ & C5PRO-ZZ Below Zero model

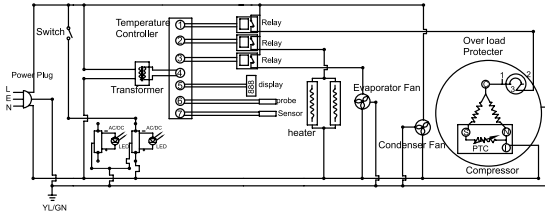

C8PRO-ZZ & C10PRO-ZZ Below Zero, no canopy

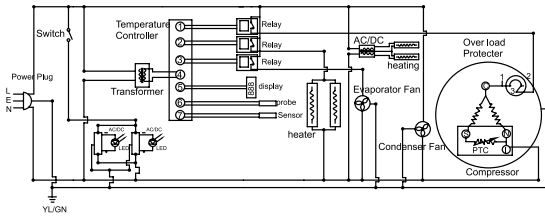

C8PRO-ZZ & C10PRO-ZZ Below Zero with canopy

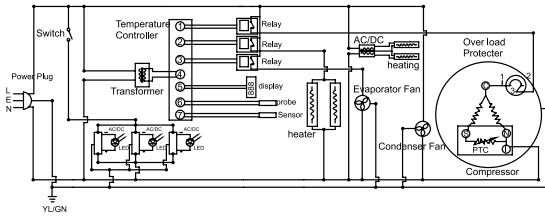

Wiring Diagram

ELECTRONIC THERMOSTAT SF-I04SB

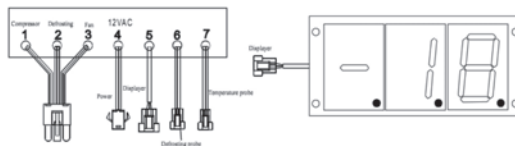



Cassette Range C4PRO-CA, C5PRO-CA, C8PRO-CA & C10PRO-CA

Operating Instructions

TO OPERATE THE ELECTRONIC THERMOSTAT

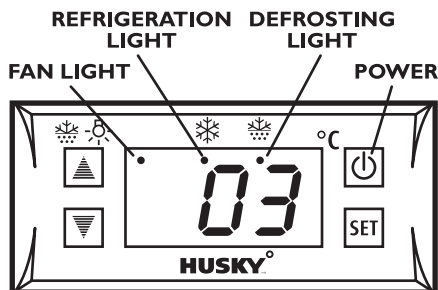

The thermostat has been pre-set, and in most cases it is not necessary to adjust the settings. When the unit is operating normally, the display will show the current temperature.

To display the set temperature press the **SET** button. Press the button again to return to normal operation.

To set a new temperature, press **SET**. The display will flash and the current set temperature will be displayed. Press the **▲** button to increase the set temperature, or press the **▼** button to decrease the set temperature. Press the **SET** button to save the new setting. The display will flash with the new value and then revert to display the cabinet temperature.

Please note:

1. When the chiller is connected to the mains for the first time there will be a short delay before cooling starts. During this time the Refrigeration Light will flash. After the short delay, cooling will begin and the Refrigeration Light will be illuminated. When the chiller reaches the set temperature, the Refrigeration Light will be off.
2. If you do not press any button, after six seconds the controller will return to its normal display.

To switch the chiller off, press **⏻** for six seconds. The display will show "--". To switch the chiller back on, press **⏻** for one second. The display will show the cabinet temperature and the unit will enter normal working mode.

DEFROSTING

The unit defrosts automatically at preset intervals. If however the door is opened too often, or if the unit is in a location with high humidity, or if the contents are changed more frequently, it may be necessary to defrost the unit manually. To start or stop manual defrosting, press the **▲** button for six seconds. The Defrosting Light will be illuminated. Melt water runs to a container placed in the compressor compartment and evaporates. After defrosting is complete, the unit will return to normal operation.

INTERIOR LIGHT

Press the **▲** button to switch the light on or off.





Exploded Diagram

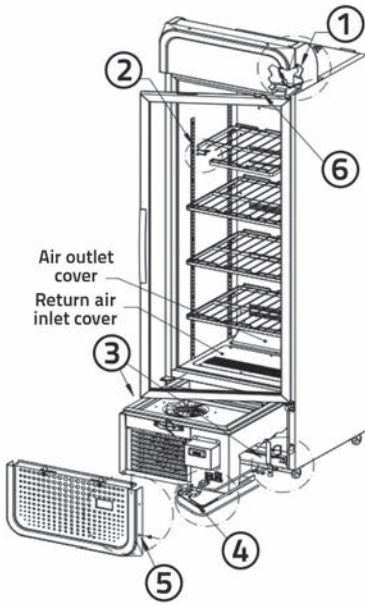

Cassette Range C5PRO-CA

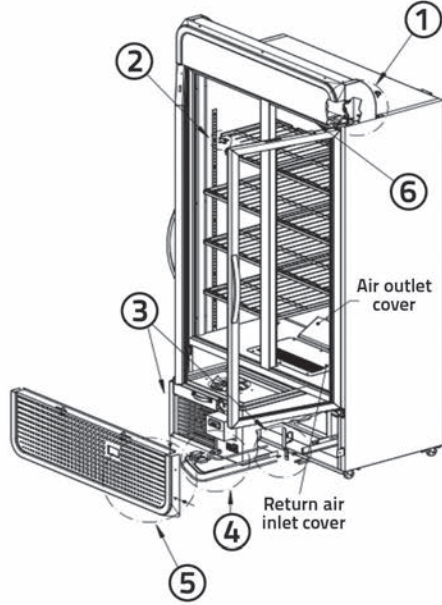

Cassette Range C10PRO-CA

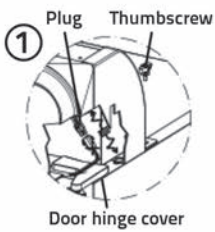

Door hinge cover



Shelf clip

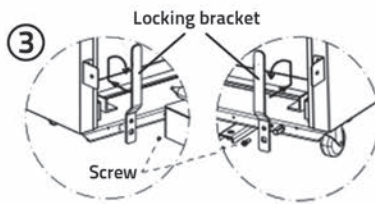

Screw

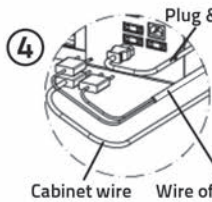

Cabinet wire

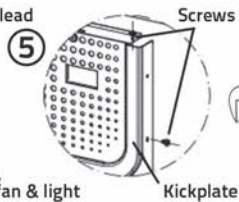

Kickplate

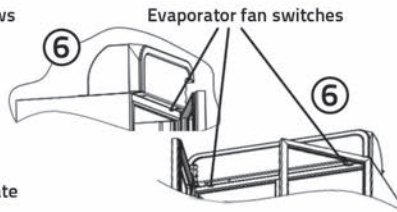

Evaporator fan switches





Cassette Range C4PRO-CA, C5PRO-CA, C8PRO-CA & C10PRO-CA

EVAPORATOR FAN

As part of the chiller's normal operation the evaporator fan will switch off automatically when the door is opened. The switch is located in the top of the door rebate (see Fig. 6 on page 23).

INSTALLING SHELVES

Fit the shelf clips to the ladder racks (see Fig. 2 on page 23) and install the shelves horizontally. Ensure the clips are located firmly and the shelves are secure before loading the chiller.

COMPRESSOR SLED – CASSETTE MODELS ONLY

QUALIFIED ENGINEERS ONLY. Husky chillers are designed for easy maintenance. The Husky Cassette Range has all major components mounted on a sliding cassette which can be removed in moments. First, switch the unit off and disconnect the plug from the mains socket. To remove the kick plate, remove two screws on the top and one screw on either side of the kick plate – see Fig. 5 on page 23. Then remove the kick plate. Four plugs will now be visible -- one each for the power, the light, the fan and the middle door post heater. Disconnect all four plugs – see Fig. 4. At the front on the cassette is a locking bracket in a vertical position. Rotate the locking bracket by 90° – see Fig. 3. You may now slide the complete cassette out.

To reassemble the unit, follow the above instructions in reverse order, ensuring locking bracket is returned to its vertical position.

FITTING/REMOVING THE ILLUMINATED CANOPY

QUALIFIED ENGINEERS ONLY. To fit the canopy, first disconnect the chiller from the power supply. Remove the right hand door hinge cover. Plug the canopy into the socket that may now be seen. See Fig. 1 on page 23. Tighten the thumb screws on both sides of the canopy to secure the canopy to the chiller. Re-connect the chiller to the power supply.

To remove the canopy, first disconnect the chiller from the power supply. Loosen the thumb screws on both sides of canopy, then pull out the plug for the canopy light – see Fig. 1 on page 23. The canopy may now be removed. Re-fit the right hand door hinge cover. Finally re-connect the chiller to the power supply.

CLEANING

The condenser and the compressor compartment **MUST** be cleaned quarterly – see 'Compressor Sled – Cassette models only' how to access the compressor compartment.

The external and internal surfaces of the unit should be cleaned regularly. Switch the unit off and disconnect the plug from the mains socket. Remove the drainage hole cover. Clean the external and internal surfaces of the unit with a mild soap solution, then wipe dry. Replace the drainage hole cover. Do NOT use cleansers containing chlorine or other harsh cleansing agents, as these can damage the stainless steel surfaces and components. Use mild soapy water to clean the gasket and seals.

GETTING SERVICE ASSISTANCE

The cooling system is a hermetically sealed circuit and does not require any maintenance other than regular cleaning (see 'Cleaning').

If the unit fails to work, first check the power supply. If you cannot locate the reason for the failure, please contact your supplier, stating the model and serial number of the cabinet. You may find this information on the rating plate, which is affixed inside the unit on the top right-hand interior wall.





Circuit Diagrams

C4PRO & C5PRO Standard Cassette model, no canopy

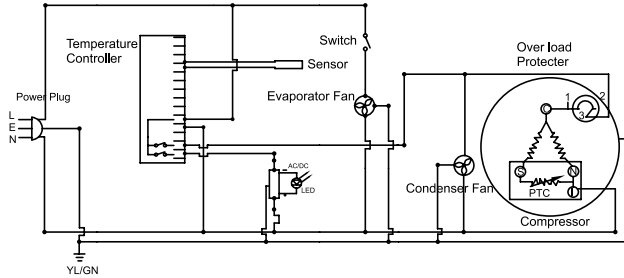

C4PRO & C5PRO Standard Cassette model with canopy

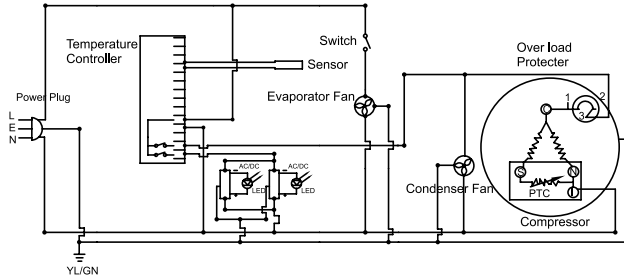

C8PRO & C10PRO Standard Cassette models, no canopy

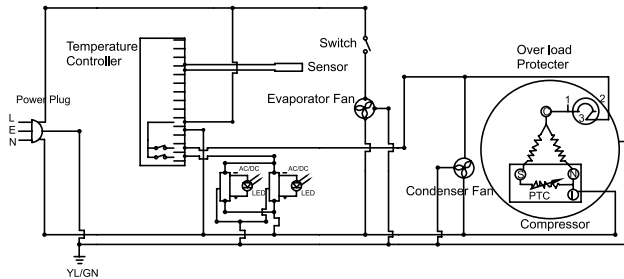



Cassette Range C4PRO-CA, C5PRO-CA, C8PRO-CA & C10PRO-CA

Circuit Diagrams

C8PRO & C10PRO Standard Cassette models with canopy

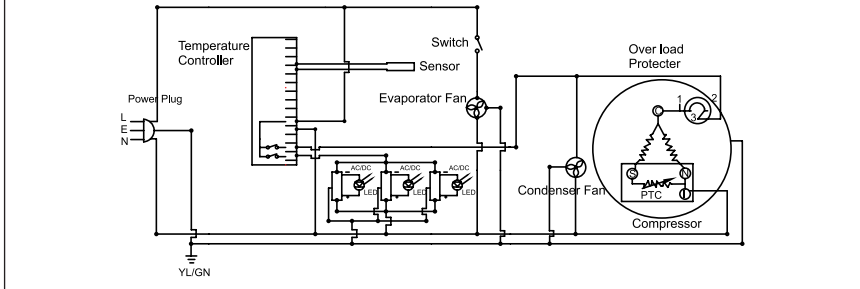

C8PRO & C10PRO Standard Cassette models with door heater, no canopy

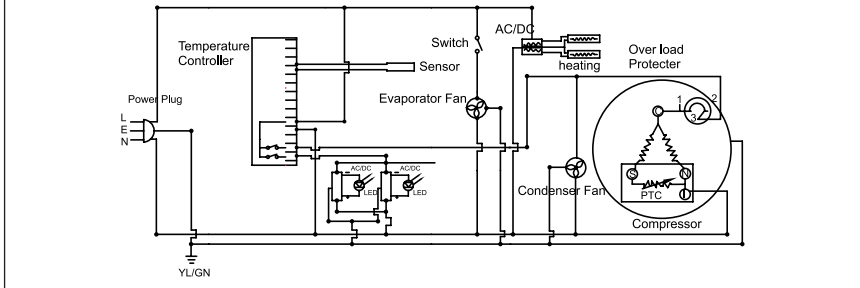

C8PRO & C10PRO Standard Cassette models with door heater and canopy

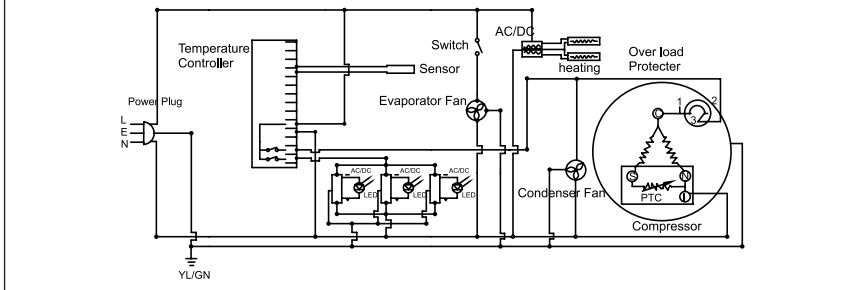



Wiring Diagram

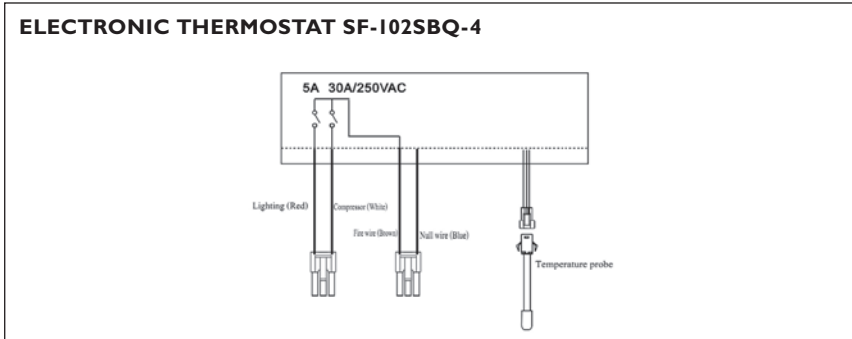



Freezer Range F5PRO & F10PRO

Operating Instructions

TO OPERATE THE ELECTRONIC THERMOSTAT

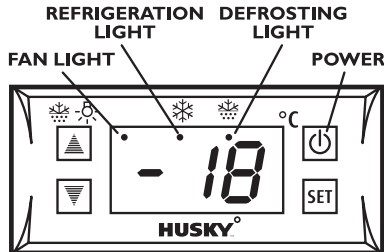

The thermostat has been pre-set, and in most cases it is not necessary to adjust the settings. When the unit is operating normally, the display will show the current temperature.

To display the set temperature press the **SET** button. Press the button again to return to normal operation.

To set a new temperature, press **SET**. The display will flash and the current set temperature will be displayed. Press the **▲** button to increase the set temperature, or press the **▼** button to decrease the set temperature. Press the **SET** button to save the new setting. The display will flash with the new value and then revert to display the cabinet temperature.

Please note:

1. When the freezer is connected to the mains for the first time there will be a short delay before cooling starts. During this time the Refrigeration Light will flash. After the short delay, cooling will begin and the Refrigeration Light will be illuminated. When the freezer reaches the set temperature, the Refrigeration Light will be off.
2. If you do not press any button, after six seconds the controller will return to its normal display.

To switch the freezer off, press **⏻** for six seconds. The display will show "- -". To switch the freezer back on, press **⏻** for one second. The display will show the cabinet temperature and the unit will enter normal working mode.

DEFROSTING

The unit defrosts automatically at preset intervals. If however the door is opened too often, or if the unit is in a location with high humidity, or if the contents are changed more frequently, it may be necessary to defrost the unit manually. To start or stop manual defrosting, press the **▲** button for six seconds. The Defrosting Light will be illuminated. Melt water runs to a container placed in the compressor compartment and evaporates. After defrosting is complete, the unit will return to normal operation.

INTERIOR LIGHT

Press the **▲** button to switch the light on or off.

EVAPORATOR FAN

As part of the freezer's normal operation the evaporator fan will switch off automatically when





Exploded Diagram

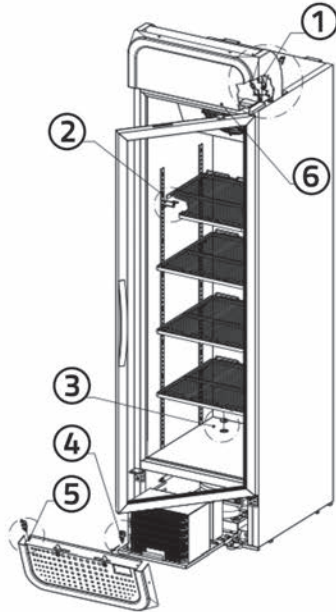

Standard Range F5PRO

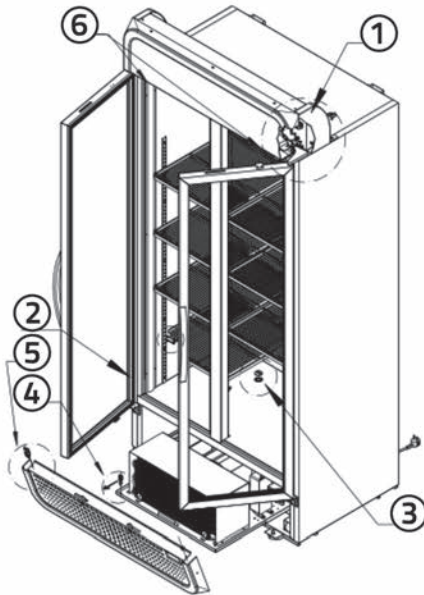

Standard Range F10PRO

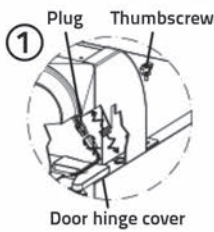

Door hinge cover



Shelf clip

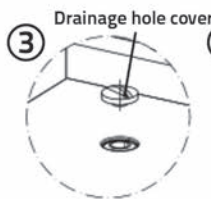

Drainage hole cover

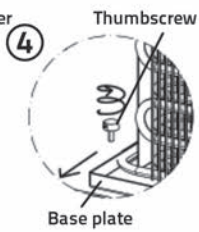

Base plate

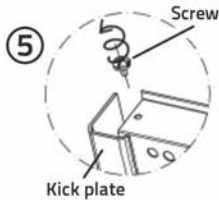

Kick plate

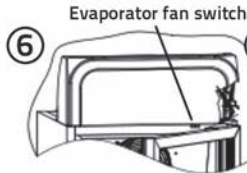

Evaporator fan switch

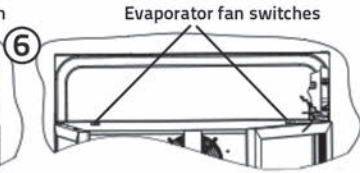

Evaporator fan switches





Freezer Range F5PRO & F10PRO

the door is opened. The switch is located in the top of the door rebate (see Fig. 6 on page 29).

INSTALLING SHELVES

Fit the shelf clips to the ladder racks (see Fig. 2 on page 29) and install the shelves horizontally. Ensure the clips are located firmly and the shelves are secure before loading the freezer.

FITTING/REMOVING THE ILLUMINATED CANOPY

COMPETENT PERSON ONLY. To fit the canopy, first disconnect the freezer from the power supply. Remove the right hand door hinge cover. Plug the canopy into the socket that may now be seen. See Fig. 1 on page 29. Tighten the thumb screws on both sides of the canopy to secure the canopy to the freezer. Re-connect the freezer to the power supply.

To remove the canopy, first disconnect the freezer from the power supply. Loosen the thumb screws on both sides of canopy, then pull out the plug for the canopy light – see Fig. 1 on page 29. The canopy may now be removed. Re-fit the right hand door hinge cover. Finally re-connect the freezer to the power supply.

EASY MAINTENANCE ACCESS

QUALIFIED ENGINEERS ONLY. Husky freezers are designed for easy maintenance. One feature is that the compressor, condenser and condenser fan are mounted on an easily-accessible sliding tray. To access this sliding tray, open the door(s) fully and loosen the two screws (which have now become accessible) on the top on either side of the kick plate – see Fig 5 on page 29. Remove the kick plate by lifting it up and pulling it forward. Loosen the thumb screws on either side of the sliding tray – see Fig. 4 on page 29. With caution slide out the sliding tray no more than 300mm.

COMPRESSOR

QUALIFIED ENGINEERS ONLY. To access the compressor, slide out the sliding tray – see 'Easy Maintenance Access'.

CLEANING

The condenser **MUST** be cleaned quarterly. Carefully remove the kick plate (see above for how to remove the kick plate) and use a soft brush to clean the condenser.

The external and internal surfaces of the unit should be cleaned regularly. Switch the unit off and disconnect the plug from the mains socket. Remove the drainage hole cover (see Fig. 3 on page 29). Clean the external and internal surfaces of the unit with a mild soap solution, then wipe dry. Replace the drainage hole cover. Do **NOT** use cleansers containing chlorine or other harsh cleansing agents, as these can damage the stainless steel surfaces and components. Use mild soapy water to clean the gasket and seals.

GETTING SERVICE ASSISTANCE

The cooling system is a hermetically sealed circuit and does not require any maintenance other than regular cleaning (see 'Cleaning').

If the unit fails to work, first check the power supply. If you cannot locate the reason for the failure, please contact your supplier, stating the model and serial number of the cabinet. You may find this information on the rating plate, which is affixed inside the unit on the top right-hand interior wall.





Circuit Diagrams

F5PRO Standard models, no canopy

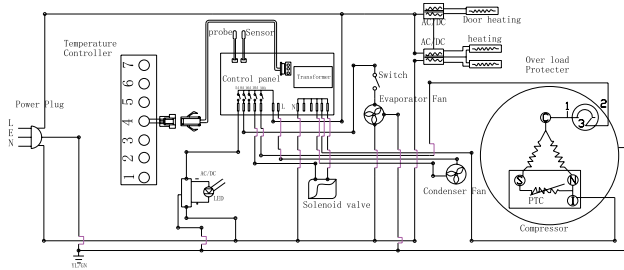

F10PRO Standard models, no canopy

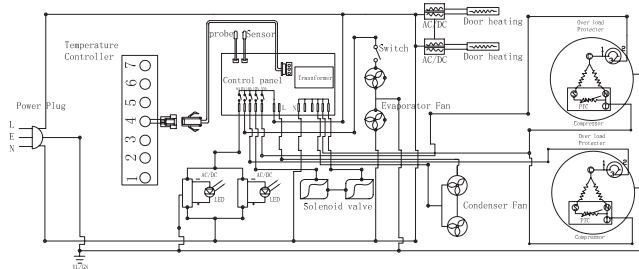

Wiring Diagram

ELECTRONIC THERMOSTAT

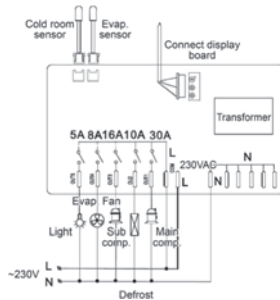



Welcome to Husky, the home of smart refrigeration. We are a leading global refrigeration specialist with over 25 years experience in quality refrigeration for convenience and hospitality professionals, and we have a great range of chillers for the home too. You'll find Husky products all over the world, so whatever your requirements we're sure to have a good looking energy-efficient model that's perfect for you.

HUSKY[®]

www.husky-international.com

www.husky.co.uk

HELPLINE/TECHNICAL SUPPORT

To contact your local technical support, refer to the rating plate on the inside wall or the back of your unit.

280317. Edition 2.

